

LME49810 200V Audio Power Amplifier Driver with Baker Clamp

Check for Samples: [LME49810](#)

FEATURES

- Very High Voltage Operation
- Output Clamp Logic Output
- Thermal Shutdown and Mute
- Customizable External Compensation
- Scalable Output Power

APPLICATIONS

- Guitar Amplifiers
- Powered Studio Monitors
- Powered Subwoofers
- Pro Audio
- Audio Video Receivers
- High Voltage Industrial Applications

KEY SPECIFICATIONS

- Wide operating voltage range: $\pm 20\text{V}$ to $\pm 100\text{V}$
- Slew Rate: $50\text{V}/\mu\text{s}$ (Typ)
- Output Drive Current: 60mA (Typ)
- PSRR (f = DC): 110dB (Typ)
- THD+N (f = 1kHz): 0.0007 (Typ)

DESCRIPTION

The LME49810 is a high fidelity audio power amplifier driver designed for demanding consumer and pro-audio applications. Amplifier output power may be scaled by changing the supply voltage and number of power transistors. The LME49810's minimum output current is 50mA . When using a discrete output stage the LME49810 is capable of delivering in excess of 300 watts into a single-ended 8Ω load.

Unique to the LME49810 is an internal Baker Clamp. This clamp insures that the amplifier output does not saturate when over driven. The resultant "soft clipping" of high level audio signals suppresses undesirable audio artifacts generated when conventional solid state amplifiers are driven hard into clipping.

The LME49810 includes thermal shutdown circuitry that activates when the die temperature exceeds 150°C . The LME49810's mute function, when activated, mutes the input drive signal and forces the amplifier output to a quiescent state.



Please be aware that an important notice concerning availability, standard warranty, and use in critical applications of Texas Instruments semiconductor products and disclaimers thereto appears at the end of this data sheet.

All trademarks are the property of their respective owners.

Typical Application

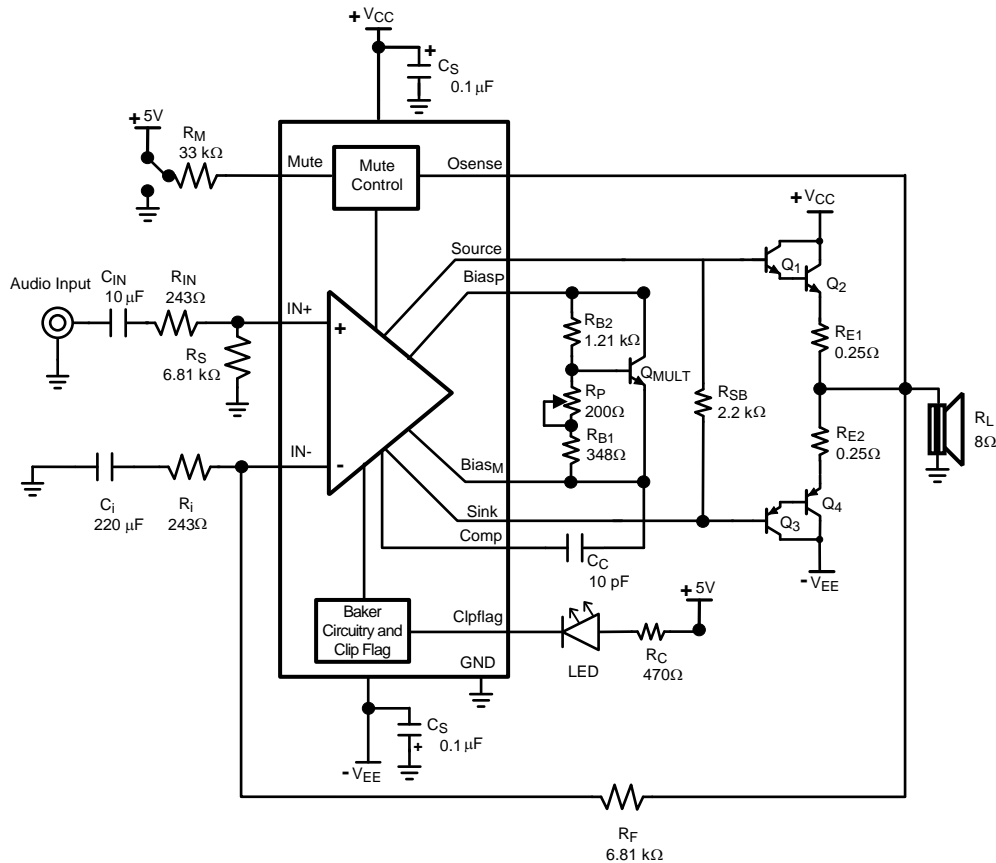

Figure 1. LME49810 Audio Amplifier Schematic

Connection Diagram

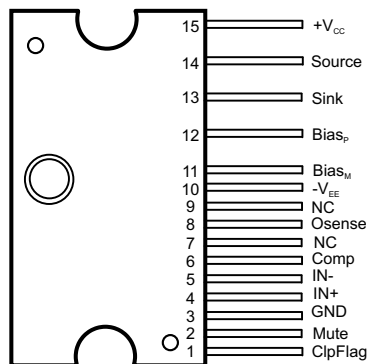

Figure 2. 15-Pin PFM (Top View)
See NDN0015A Package

PIN DESCRIPTIONS

Pin	Pin Name	Description
1	ClpFlag	Baker Clamp Clip Flag Output
2	Mute	Mute Control
3	GND	Device Ground
4	IN+	Non-Inverting Input
5	IN-	Inverting Input
6	Comp	External Compensation Connection
7	NC	No Connect, Pin electrically isolated
8	Osense	Output Sense
9	NC	No Connect, Pin electrically isolated
10	-V _{EE}	Negative Power Supply
11	Bias _M	Negative External Bias Control
12	Bias _P	Positive External Bias Control
13	Sink	Output Sink
14	Source	Output Source
15	+V _{CC}	Positive Power Supply

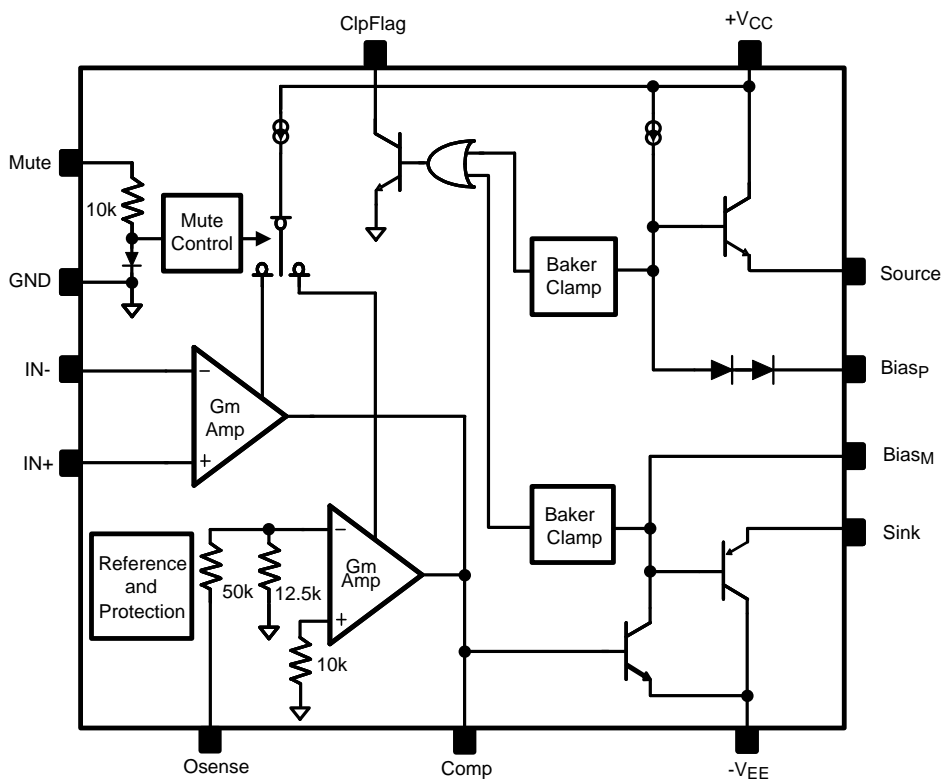

Figure 3. LME49810 Simplified Schematic



These devices have limited built-in ESD protection. The leads should be shorted together or the device placed in conductive foam during storage or handling to prevent electrostatic damage to the MOS gates.

ABSOLUTE MAXIMUM RATINGS⁽¹⁾⁽²⁾⁽³⁾

Supply Voltage $ V^+ + V^- $		200V
Differential Input Voltage		$\pm 6V$
Common Mode Input Range		$0.4V_{EE}$ to $0.4V_{CC}$
Power Dissipation ⁽⁴⁾		4W
ESD Susceptibility ⁽⁵⁾		1kV
ESD Susceptibility ⁽⁶⁾		200V
Junction Temperature (T_{JMAX}) ⁽⁷⁾		150°C
Soldering Information	PFM Package (10 seconds)	260°C
Storage Temperature		-40°C to +150°C
Thermal Resistance	θ_{JA}	73°C/W
	θ_{JC}	4°C/W

- (1) All voltages are measured with respect to the GND pin unless otherwise specified.
- (2) Absolute Maximum Ratings indicate limits beyond which damage to the device may occur. Operating Ratings indicate conditions for which the device is functional but do not ensure specific performance limits. Electrical Characteristics state DC and AC electrical specifications under particular test conditions which ensure specific performance limits. This assumes that the device is within the Operating Ratings. Specifications are not for parameters where no limit is given, however, the typical value is a good indication of device performance.
- (3) If Military/Aerospace specified devices are required, please contact the Texas Instruments Sales Office/ Distributors for availability and specifications.
- (4) The maximum power dissipation must be derated at elevated temperatures and is dictated by T_{JMAX} , θ_{JC} , and the ambient temperature, T_A . The maximum allowable power dissipation is $P_{DMAX} = (T_{JMAX} - T_A) / \theta_{JC}$ or the number given in Absolute Maximum Ratings, whichever is lower. For the LME49810, $T_{JMAX} = 150^\circ\text{C}$ and the typical θ_{JC} is 4°C/W .
- (5) Human body model, 100pF discharged through a 1.5k Ω resistor.
- (6) Machine Model, 220pF - 240pF discharged through all pins.
- (7) The maximum operating junction temperature is 150°C.

OPERATING RATINGS

Temperature Range	$T_{MIN} \leq T_A \leq T_{MAX}$	$-40^\circ\text{C} \leq T_A \leq +85^\circ\text{C}$
Supply Voltage		$\pm 20V \leq V_{SUPPLY} \leq \pm 100V$

ELECTRICAL CHARACTERISTICS $V_{CC} = +100V$, $V_{EE} = -100V$ ⁽¹⁾⁽²⁾

The following specifications apply for $I_{MUTE} = 100\mu\text{A}$, unless otherwise specified. Limits apply for $T_A = 25^\circ\text{C}$, $C_C = 10\text{pF}$, and $A_V = 29\text{dB}$.

Symbol	Parameter	Conditions	LME49810		Units (Limits)
			Typical ⁽³⁾	Limits ⁽⁴⁾⁽⁵⁾	
I_{CC}	Quiescent Power Supply Current	$V_{CM} = 0V$, $V_O = 0V$, $I_O = 0A$	11	18	mA (max)
I_{EE}	Quiescent Power Supply Current	$V_{CM} = 0V$, $V_O = 0V$, $I_O = 0A$	13		mA (max)
THD+N	Total Harmonic Distortion + Noise	No Load, BW = 30kHz, $V_{OUT} = 30V_{RMS}$, $f = 1\text{kHz}$	0.0007		% (max)
A_V	Open Loop Gain	$f = \text{DC}$ $f = 1\text{kHz}$, $V_{IN} = 1mV_{RMS}$	120 88		dB dB
V_{OM}	Output Voltage Swing	THD+N = 0.05%, $f = 1\text{kHz}$	67.5		V_{RMS}
V_{NOISE}	Output Noise	BW = 30kHz, A-weighted	50 34	150	μV μV (max)
I_{OUT}	Output Current	Current from Source to Sink Pins	60	50	mA (min)
I_{MUTE}	Current into Mute Pin	To activate the amplifier	100	50 200	μA (min) μA (max)

- (1) All voltages are measured with respect to the GND pin unless otherwise specified.
- (2) Absolute Maximum Ratings indicate limits beyond which damage to the device may occur. Operating Ratings indicate conditions for which the device is functional but do not ensure specific performance limits. Electrical Characteristics state DC and AC electrical specifications under particular test conditions which ensure specific performance limits. This assumes that the device is within the Operating Ratings. Specifications are not for parameters where no limit is given, however, the typical value is a good indication of device performance.
- (3) Typicals are measured at +25°C and represent the parametric norm.
- (4) Limits are specified to AOQL (Average Outgoing Quality Level).
- (5) Data sheet min and max specification limits are specified by design, test, or statistical analysis.

ELECTRICAL CHARACTERISTICS $V_{CC} = +100V$, $V_{EE} = -100V^{(1)(2)}$ (continued)

The following specifications apply for $I_{MUTE} = 100\mu A$, unless otherwise specified. Limits apply for $T_A = 25^\circ C$, $C_C = 10pF$, and $A_V = 29dB$.

Symbol	Parameter	Conditions	LME49810		Units (Limits)
			Typical ⁽³⁾	Limits ⁽⁴⁾⁽⁵⁾	
SR	Slew Rate	$V_{IN} = 1V_{P-P}$, $f = 10kHz$ square Wave	50		V/ μs (min)
V_{OS}	Input Offset Voltage	$V_{CM} = 0V$, $I_O = 0mA$	1	3	mV (max)
I_B	Input Bias Current	$V_{CM} = 0V$, $I_O = 0mA$	100	200	nA (max)
PSRR	Power Supply Rejection Ratio	$f = DC$, Input Referred	110	105	dB (min)
V_{CLIP}	Baker Clamp Clipping Voltage	Clip Output Source pin Sink pin	97.2 -96.4	95.5 -95.5	V (max) V (min)
V_{BC}	Baker Clamp Flag Output Voltage	$I_{FLAG} = 4.7mA$	0.4		V
V_{BA}	Bias P&M Pin Open Voltage	BiasP - BiasM	10		V
I_{BIAS}	Bias Adjust Function Current		2.8		mA

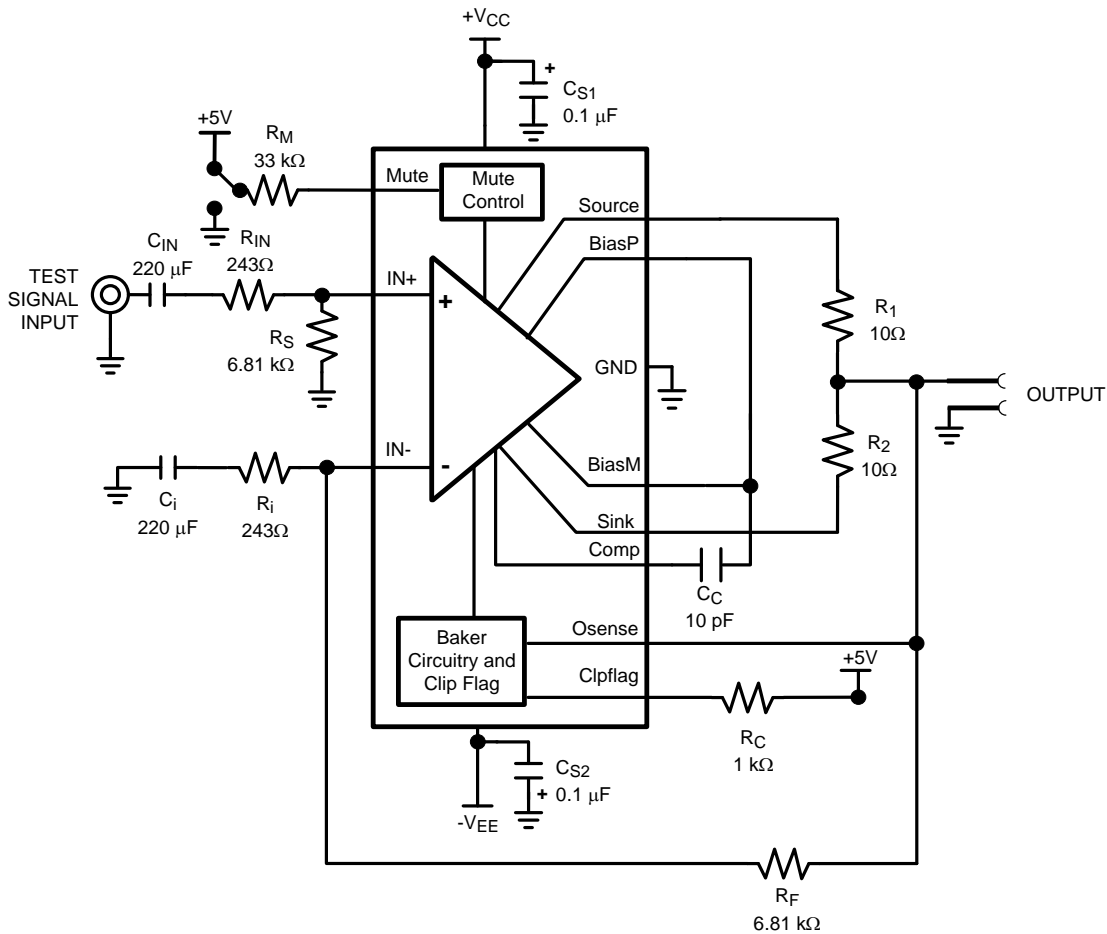

Figure 4. LME49810 Test Circuit Schematic (DC Coupled)

TYPICAL PERFORMANCE CHARACTERISTICS

Data taken with Bandwidth = 30kHz, AV = 29dB, CC = 10pF, and TA = 25°C except where specified.

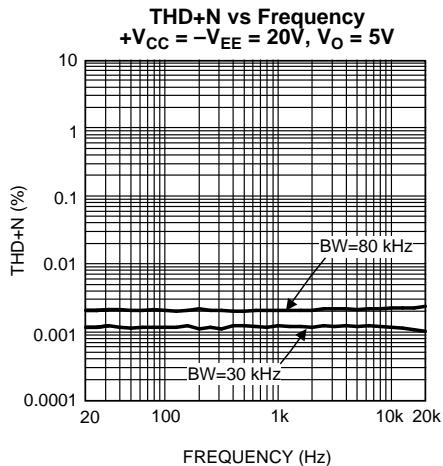

Figure 5.

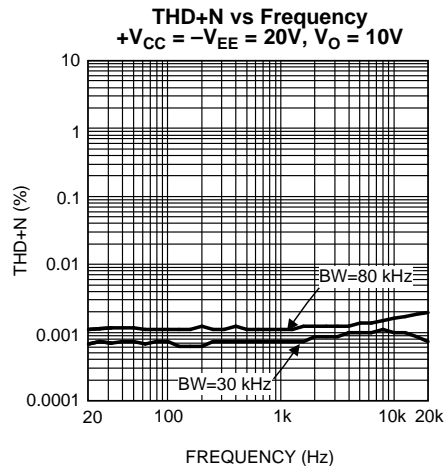

Figure 6.

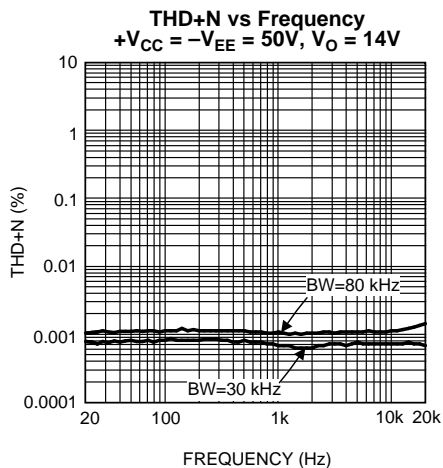

Figure 7.

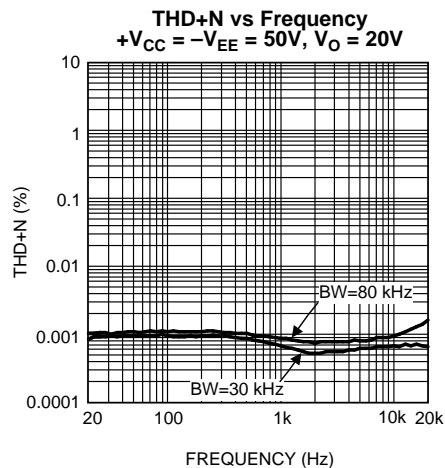

Figure 8.

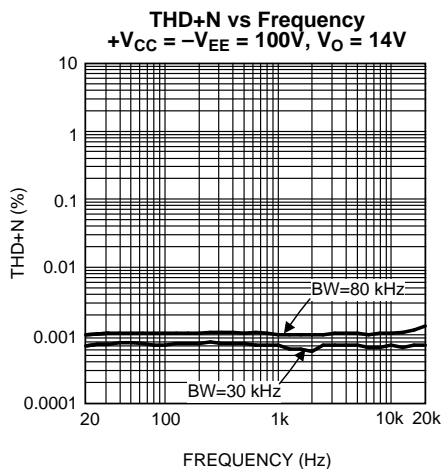

Figure 9.

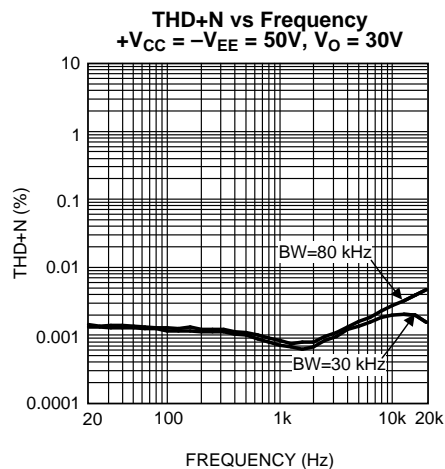

Figure 10.

TYPICAL PERFORMANCE CHARACTERISTICS (continued)

Data taken with Bandwidth = 30kHz, AV = 29dB, CC = 10pF, and TA = 25°C except where specified.

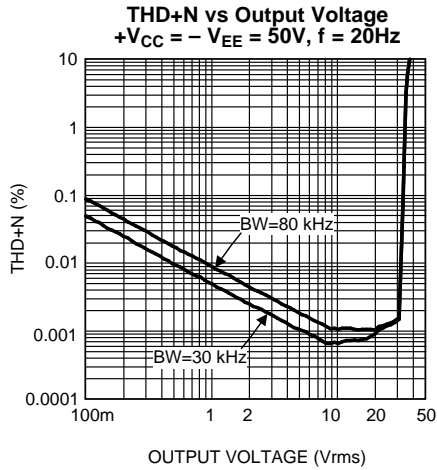

Figure 11.

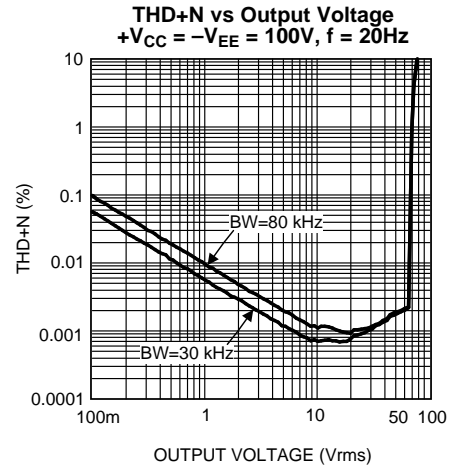

Figure 12.

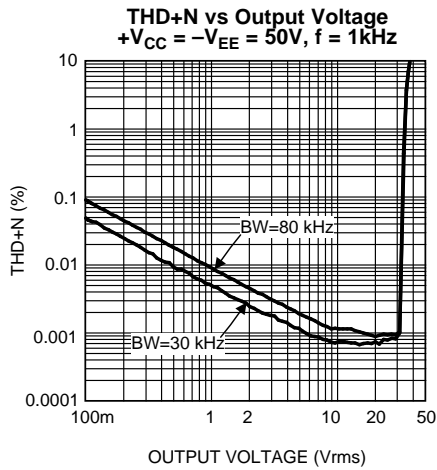

Figure 13.

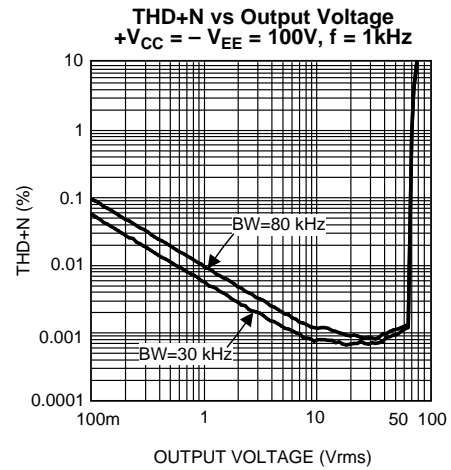

Figure 14.

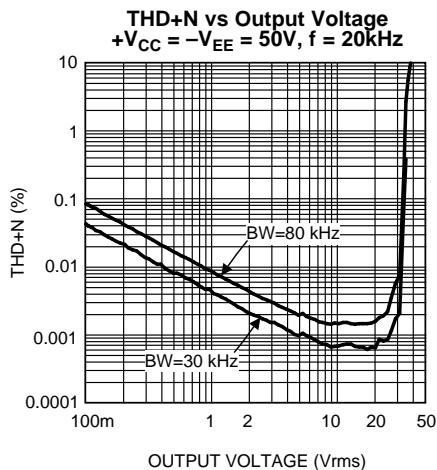

Figure 15.

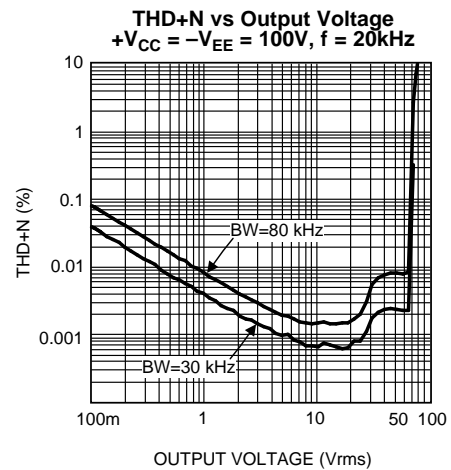

Figure 16.

TYPICAL PERFORMANCE CHARACTERISTICS (continued)

Data taken with Bandwidth = 30kHz, AV = 29dB, CC = 10pF, and TA = 25°C except where specified.

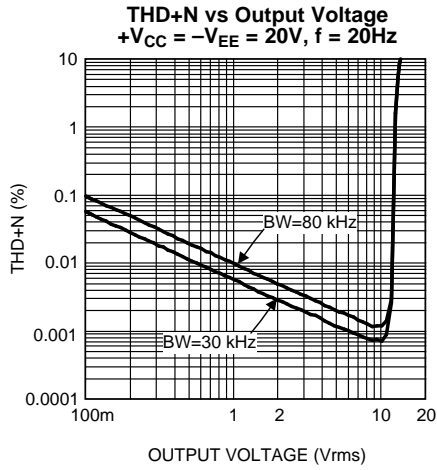

Figure 17.

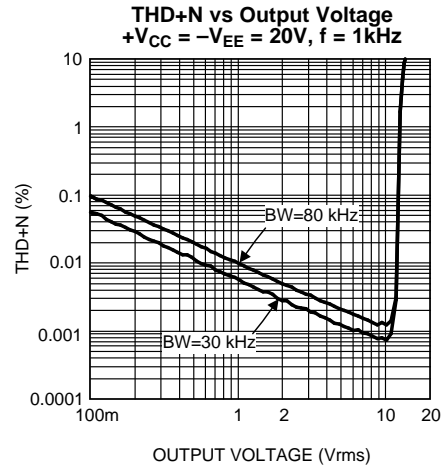

Figure 18.

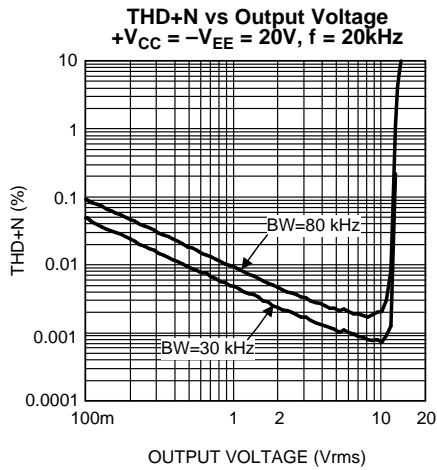

Figure 19.

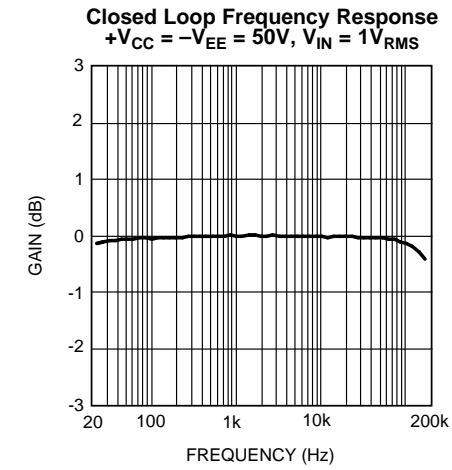

Figure 20.

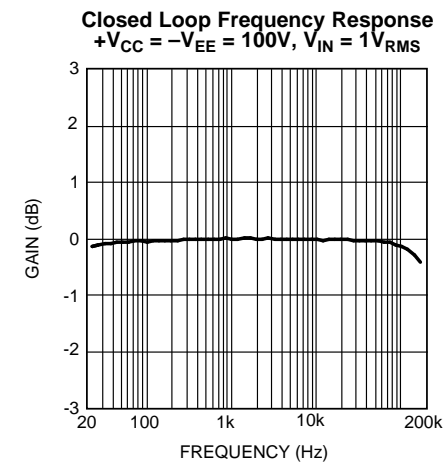

Figure 21.

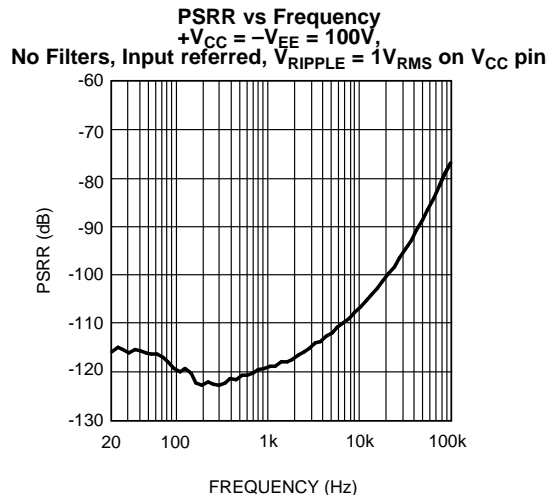

Figure 22.

TYPICAL PERFORMANCE CHARACTERISTICS (continued)

Data taken with Bandwidth = 30kHz, AV = 29dB, CC = 10pF, and TA = 25°C except where specified.

PSRR vs Frequency
 $+V_{CC} = -V_{EE} = 100V$,
 No Filters, Input referred, $V_{RIPPLE} = 1V_{RMS}$ on V_{EE} pin

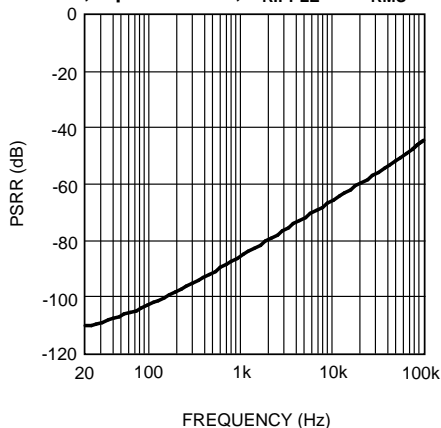

Figure 23.

Mute Attenuation vs I_{MUTE}
 $+V_{CC} = -V_{EE} = 100V$

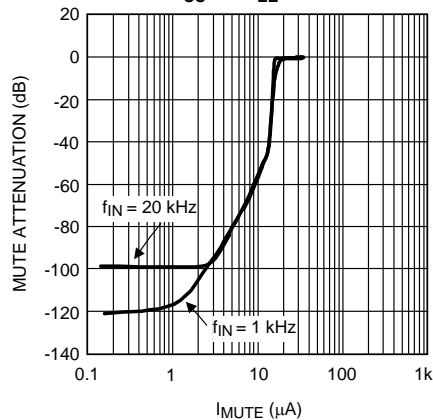

Figure 24.

Output Voltage vs Supply Voltage

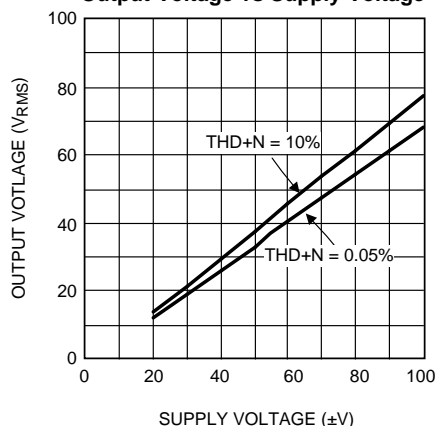

Figure 25.

Slew Rate vs Compensation Capacitor
 $+V_{CC} = -V_{EE} = 100V$, $V_{IN} = 1.2V_P$ 10kHz squarewave

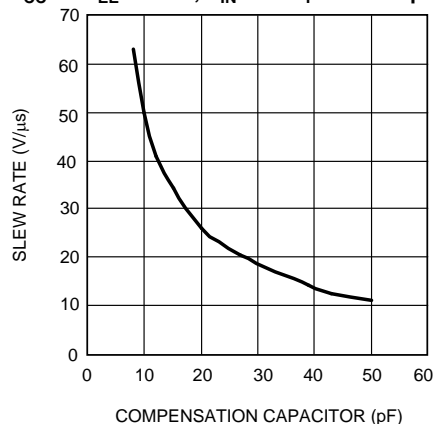

Figure 26.

Supply Current vs Supply Voltage

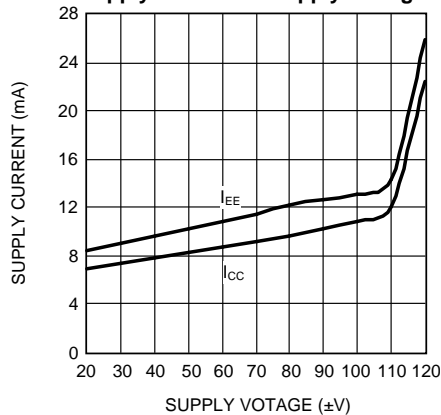

Figure 27.

Input Offset Voltage vs Supply Voltage

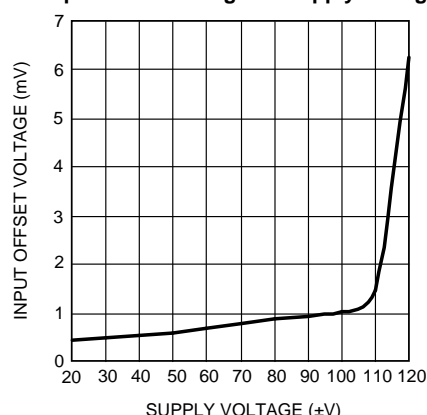

Figure 28.

TYPICAL PERFORMANCE CHARACTERISTICS (continued)

Data taken with Bandwidth = 30kHz, AV = 29dB, CC = 10pF, and TA = 25°C except where specified.

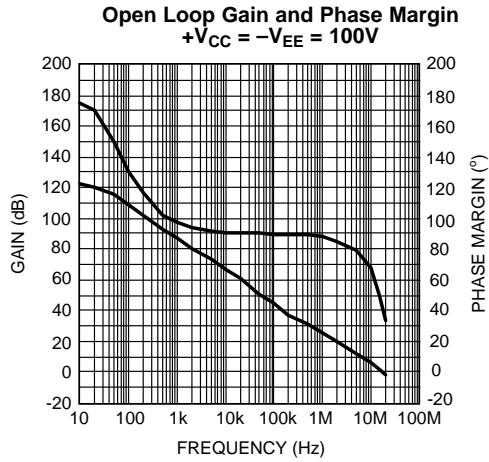

Figure 29.

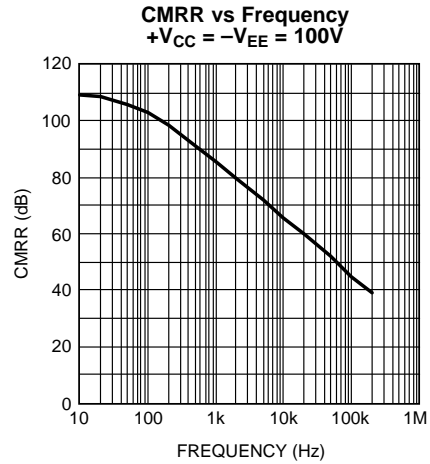

Figure 30.

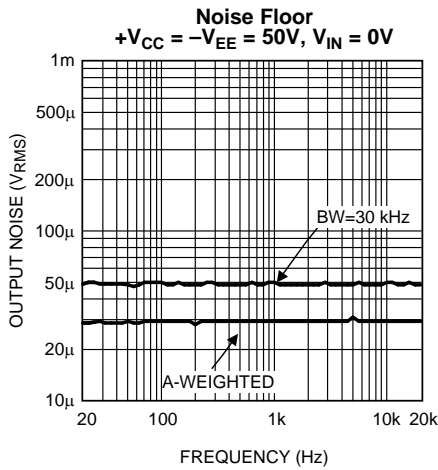

Figure 31.

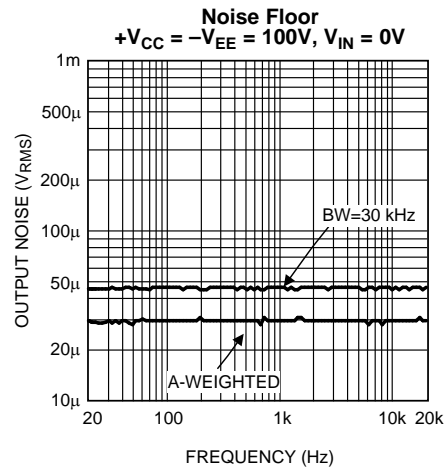

Figure 32.

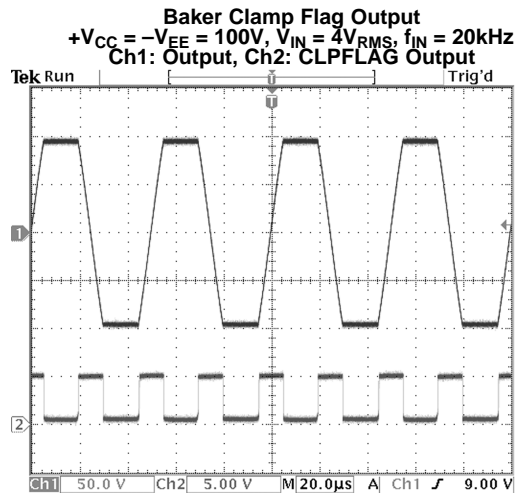

Figure 33.

APPLICATION INFORMATION

MUTE FUNCTION

The mute function of the LME49810 is controlled by the amount of current that flows into the MUTE pin. LME49810 typically requires 50µA to 100µA of mute current flowing in order to be in “play” mode. This can be done by connecting a reference voltage (V_{MUTE}) to the MUTE pin through a resistor (R_M). The following formula can be used to calculate the mute current.

$$I_{MUTE} = (V_{MUTE} - 0.7V) / (R_M + 10k\Omega) \quad (A) \quad (1)$$

The 10kΩ resistor value in Equation (1) is internal. Please refer to Figure 3, LME49810 Simplified Schematic, for additional details. For example, if a 5V voltage is connected through a 33kΩ resistor to the MUTE pin, then the mute current will be 100µA, according to Equation (1). Consequently, R_M can be changed to suit any other reference voltage requirement. The LME49810 will enter Mute mode if I_{MUTE} is less than 1µA which can be accomplished by shorting the MUTE pin to ground or by floating the MUTE pin. It is not recommended that more than 200µA flow into the MUTE pin because damage to LME49810 may occur and device may not function properly.

BAKER CLAMP AND CLAMP FLAG OUTPUT

The LME49810 features a Baker Clamp function with corresponding CLPFLAG output pin. The clamp function keeps all transistors in linear operation when the output goes into clipping. In addition, when the output goes into clipping, a logic low level appears at the CLPFLAG pin. The CLPFLAG pin can be used to drive an LED or some other visual display as shown by Figure 1. The value of logic low voltage varies and depends on I_{FLAG} . For example, if I_{FLAG} is 4.7mA then a voltage (V_{BC}) of 0.4V will appear at the CLPFLAG output pin. The smooth response of the Baker Clamp and the corresponding CLPFLAG logic output is shown in the scope photo below:

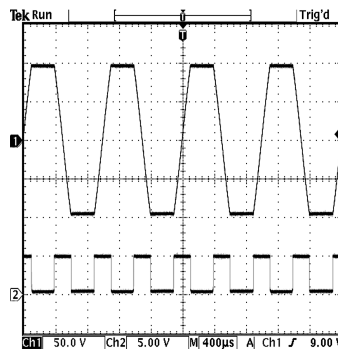

+V_{CC} = -V_{EE} = 100V,
V_{IN} = 4V_{RMS},
f_{IN} = 1kHz,
R_C = 1kΩ Ch1: Output,
Ch2: CLPFLAG Output

Figure 34.

The CLPFLAG pin can source up to 10mA, and since the CLPFLAG output is an open collector output as shown by Figure 3, LME49810 Simplified Schematic, it should never be left to float under normal operation. If CLPFLAG pin is not used, then it should be connected through a resistor to a reference voltage so that I_{FLAG} is below 10mA. For example, a resistor of 1k can be used with a 5V reference voltage. This will give the I_{FLAG} of 4.7mA. In a typical LED setup, if +5V reference voltage is not available, the following circuit using a Zener diode can be used to power the CLPFLAG pin from the higher supply voltage rails of the LME49810. The power dissipation rating of R_Z will need to be at-least ½W if using a 5V Zener Diode. Alternately, the following basic formula can be used to find the proper power rating of R_Z : $P_{DZ} = (V_{CC} - V_Z)^2 / R_Z$ (W). This formula can also be used to meet the design requirements of any other reference voltage that the user desires.

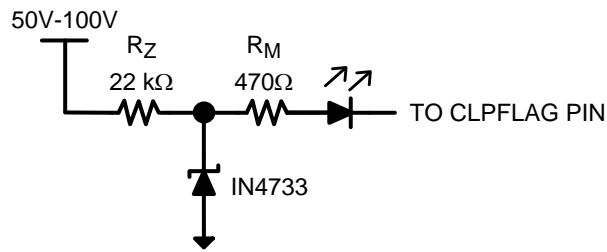

THERMAL PROTECTION

The LME49810 has a thermal protection scheme to prevent long-term thermal stress of the device. When the temperature on the die exceeds 150°C, the LME49810 goes into thermal shutdown. The LME49810 starts operating again when the die temperature drops to about 145°C, but if the temperature again begins to rise, shutdown will occur again above 150°C. Therefore, the device is allowed to heat up to a relatively high temperature if the fault condition is temporary, but a sustained fault will cause the device to cycle between the thermal shutdown temperature limits of 150°C and 145°C. This greatly reduces the stress imposed on the IC by thermal cycling, which in turn improves its reliability under sustained fault conditions. Since the die temperature is directly dependent upon the heat sink used, the heat sink should be chosen so that thermal shutdown is not activated during normal operation. Using the best heat sink possible within the cost and space constraints of the system will improve the long-term reliability of any power semiconductor device, as discussed in the [DETERMINING THE CORRECT HEAT SINK](#) section.

POWER DISSIPATION

When in “play” mode, the LME49810 draws a constant amount of current, regardless of the input signal amplitude. Consequently, the power dissipation is constant for a given supply voltage and can be computed with the equation $P_{DMAX} = I_{CC} * (V_{CC} - V_{EE})$. For a quick calculation of P_{DMAX} , approximate the current to be 11mA and multiply it by the total supply voltage (the current varies slightly from this value over the operating range).

DETERMINING THE CORRECT HEAT SINK

The choice of a heat sink for a high-power audio amplifier is made entirely to keep the die temperature at a level such that the thermal protection circuitry is not activated under normal circumstances.

The thermal resistance from the die to the outside air, θ_{JA} (junction to ambient), is a combination of three thermal resistances, θ_{JC} (junction to case), θ_{CS} (case to sink), and θ_{SA} (sink to ambient). The thermal resistance, θ_{JC} (junction to case), of the LME49810 is 4°C/W. Using Thermalloy Thermacote thermal compound, the thermal resistance, θ_{CS} (case to sink), is about 0.2°C/W. Since convection heat flow (power dissipation) is analogous to current flow, thermal resistance is analogous to electrical resistance, and temperature drops are analogous to voltage drops, the power dissipation out of the LME49810 is equal to the following:

$$P_{DMAX} = (T_{JMAX} - T_{AMB}) / \theta_{JA}$$

where

- $T_{JMAX} = 150^{\circ}\text{C}$
- T_{AMB} is the system ambient temperature
- $\theta_{JA} = \theta_{JC} + \theta_{CS} + \theta_{SA}$

(2)

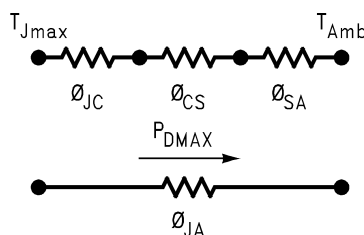

Once the maximum package power dissipation has been calculated using [Equation \(2\)](#), the maximum thermal resistance, θ_{SA} , (heat sink to ambient) in °C/W for a heat sink can be calculated. This calculation is made using [Equation \(3\)](#) which is derived by solving for θ_{SA} from [Equation \(2\)](#).

$$\theta_{SA} = [(T_{JMAX} - T_{AMB}) - P_{DMAX}(\theta_{JC} + \theta_{CS})] / P_{DMAX} \quad (3)$$

Again it must be noted that the value of θ_{SA} is dependent upon the system designer's amplifier requirements. If the ambient temperature that the audio amplifier is to be working under is higher than 25°C, then the thermal resistance for the heat sink, given all other things are equal, will need to be smaller.

PROPER SELECTION OF EXTERNAL COMPONENTS

Proper selection of external components is required to meet the design targets of an application. The choice of external component values that will affect gain and low frequency response are discussed below.

The overall gain of the amplifier is set by resistors R_F and R_i for the non-inverting configuration shown in [Figure 1](#). The gain is found by [Equation \(4\)](#) below given $R_i = R_{IN}$ and $R_F = R_S$.

$$A_V = R_F / R_i \text{ (V/V)} \quad (4)$$

For best Noise performance, lower values of resistors are used. A value of 243 is commonly used for R_i and setting the value for R_F for desired gain. For the LME49810 the gain should be set no lower than 10V/V. Gain settings below 10V/V may experience instability.

The combination of R_i and C_i (see [Figure 1](#)) creates a high pass filter. The gain at low frequency and therefore the response is determined by these components. The -3dB point can be determined from [Equation \(5\)](#) shown below:

$$f_i = 1 / (2\pi R_i C_i) \text{ (Hz)} \quad (5)$$

If an input coupling capacitor (C_{IN}) is used to block DC from the inputs as shown in [Figure 1](#), there will be another high pass filter created with the combination of C_{IN} and R_{IN} . The resulting -3dB frequency response due to the combination of C_{IN} and R_{IN} can be found from [Equation \(6\)](#) shown below:

$$f_{IN} = 1 / (2\pi R_{IN} C_{IN}) \text{ (Hz)} \quad (6)$$

For best audio performance, the input capacitor should not be used. Without the input capacitor, any DC bias from the source will be transferred to the load. The feedback capacitor (C_i) is used to set the gain at DC to unity. Because a large value is required for a low frequency -3dB point, the capacitor is an electrolytic type. An additional small value, high quality film capacitor may be used in parallel with the feedback resistor to improve high frequency sonic performance. If DC offset in the output stage is acceptable without the feedback capacitor, it may be removed but DC gain will now be equal to AC gain.

COMPENSATION CAPACITOR

The compensation capacitor (C_C) is one of the most critical external components in value, placement and type. The capacitor should be placed close to the LME49810 and a silver mica type will give good performance. The value of the capacitor will affect slew rate and stability. The highest slew rate is possible while also maintaining stability through out the power and frequency range of operation results in the best audio performance. The value shown in [Figure 1](#) should be considered a starting value with optimization done on the bench and in listening testing. Please refer to Slew Rate vs. C_C Graph in [TYPICAL PERFORMANCE CHARACTERISTICS](#) for determining the proper slew rate for your particular application.

SUPPLY BYPASSING

The LME49810 has excellent power supply rejection and does not require a regulated supply. However, to eliminate possible oscillations all op amps and power op amps should have their supply leads bypassed with low-inductance capacitors having short leads and located close to the package terminals. Inadequate power supply bypassing will manifest itself by a low frequency oscillation known as "motorboating" or by high frequency instabilities. These instabilities can be eliminated through multiple bypassing utilizing a large electrolytic capacitor (10 μ F or larger) which is used to absorb low frequency variations and a small ceramic capacitor (0.1 μ F) to prevent any high frequency feedback through the power supply lines. If adequate bypassing is not provided the current in the supply leads which is a rectified component of the load current may be fed back into internal circuitry. This signal causes low distortion at high frequencies requiring that the supplies be bypassed at the package terminals with an electrolytic capacitor of 470 μ F or more.

OUTPUT STAGE USING BIPOLAR TRANSISTORS

With a properly designed output stage and supply voltage of $\pm 100\text{V}$, an output power up to 500W can be generated at 0.05% THD+N into an 8Ω speaker load. With an output current of several amperes, the output transistors need substantial base current drive because power transistors usually have quite low current gain—typical h_{fe} of 50 or so. To increase the current gain, audio amplifiers commonly use Darlington style devices. Power transistors should be mounted together with the V_{BE} multiplier transistor on the same heat sink to avoid thermal run away. Please see the section [BIASING TECHNIQUES AND AVOIDING THERMAL RUNAWAY](#) for additional information.

BIASING TECHNIQUES AND AVOIDING THERMAL RUNAWAY

A class AB amplifier has some amount of distortion called Crossover distortion. To effectively minimize the crossover distortion from the output, a V_{BE} multiplier may be used instead of two biasing diodes. The LME49810 has two dedicated pins (BIAS_M and BIAS_P) for Bias setup and provide a constant current source of about 2.8mA. A V_{BE} multiplier normally consists of a bipolar transistor (Q_{MULT} , see [Figure 1](#)) and two resistors (R_{B1} and R_{B2} , see [Figure 1](#)). A trim pot can also be added in series with R_{B1} for optional bias adjustment. A properly designed output stage, combine with a V_{BE} multiplier, can eliminate the trim pot and virtually eliminate crossover distortion. The V_{CE} voltage of Q_{MULT} (also called BIAS of the output stage) can be set by following formula:

$$V_{BIAS} = V_{BE}(1+R_{B2}/R_{B1}) \text{ (V)} \quad (7)$$

When using a bipolar output stage with the LME49810 (as in [Figure 1](#)), the designer must beware of thermal runaway. Thermal runaway is a result of the temperature dependence of V_{BE} (an inherent property of the transistor). As temperature increases, V_{BE} decreases. In practice, current flowing through a bipolar transistor heats up the transistor, which lowers the V_{BE} . This in turn increases the current gain, and the cycle repeats. If the system is not designed properly this positive feedback mechanism can destroy the bipolar transistors used in the output stage. One of the recommended methods of preventing thermal runaway is to use the same heat sink on the bipolar output stage transistor together with V_{BE} multiplier transistor. When the V_{BE} multiplier transistor is mounted to the same heat sink as the bipolar output stage transistors, its temperature will track that of the output transistors. Its V_{BE} is dependent upon temperature as well, and so it will draw more current as the output transistors heat up, reducing the bias voltage to compensate. This will limit the base current into the output transistors, which counteracts thermal runaway. Another widely popular method of preventing thermal runaway is to use low value emitter degeneration resistors (R_{E1} and R_{E2}). As current increases, the voltage at the emitter also increases, which decreases the voltage across the base and emitter. This mechanism helps to limit the current and counteracts thermal runaway.

LAYOUT CONSIDERATION AND AVOIDING GROUND LOOPS

A proper layout is virtually essential for a high performance audio amplifier. It is very important to return the load ground, supply grounds of output transistors, and the low level (feedback and input) grounds to the circuit board common ground point through separate paths. When ground is routed in this fashion, it is called a star ground or a single point ground. It is advisable to keep the supply decoupling capacitors of $0.1\mu\text{F}$ close as possible to LME49810 to reduce the effects of PCB trace resistance and inductance. Following the general rules will optimize the PCB layout and avoid ground loops problems:

- a. Make use of symmetrical placement of components.
- b. Make high current traces, such as output path traces, as wide as possible to accommodate output stage current requirement.
- c. To reduce the PCB trace resistance and inductance, same ground returns paths should be as short as possible. If possible, make the output traces short and equal in length.
- d. To reduce the PCB trace resistance and inductance, ground returns paths should be as short as possible.
- e. If possible, star ground or a single point ground should be observed. Advanced planning before starting the PCB can improve audio performance.

Demo Board Schematic

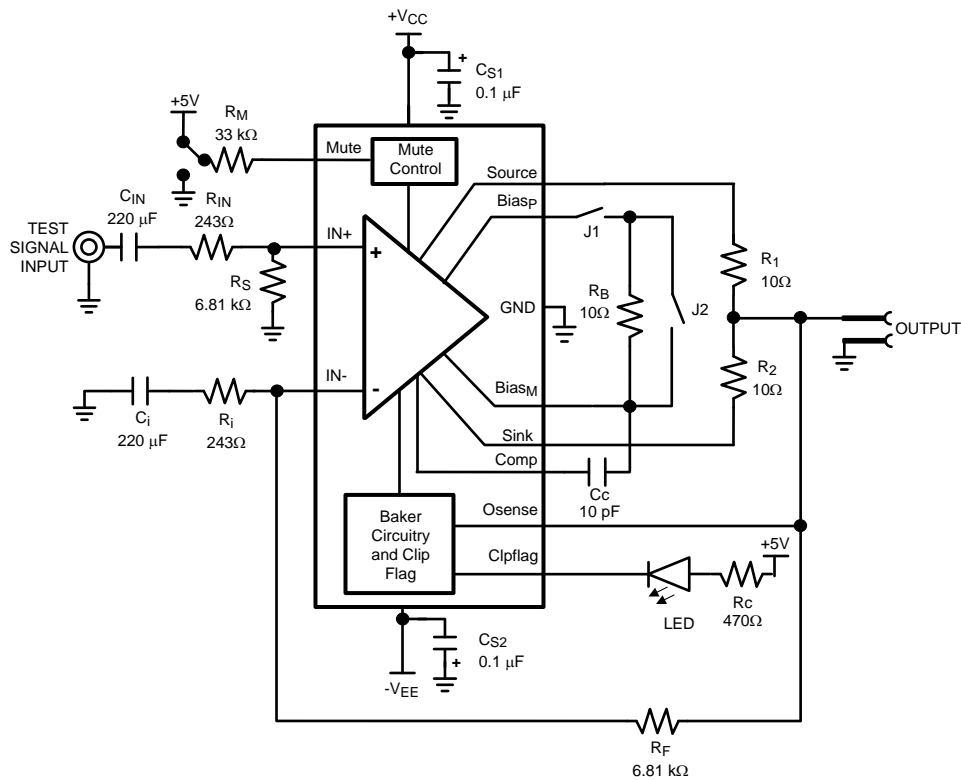

Figure 35. LME49810 Test Demo Board Schematic

Demonstration Board Layout

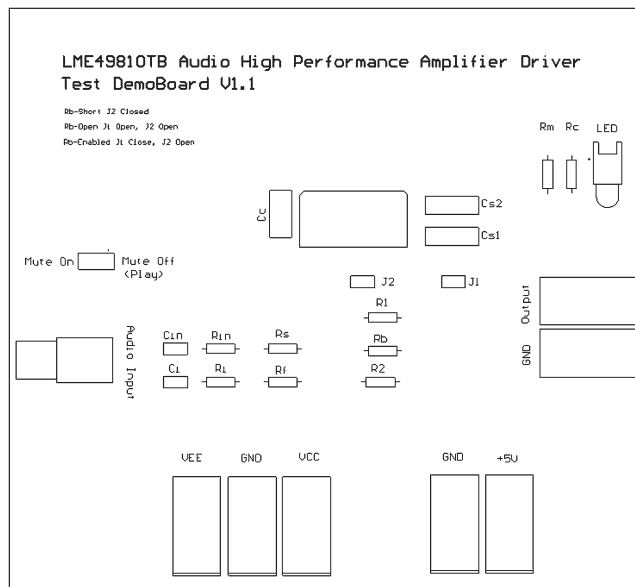

Figure 36. Silkscreen Layer

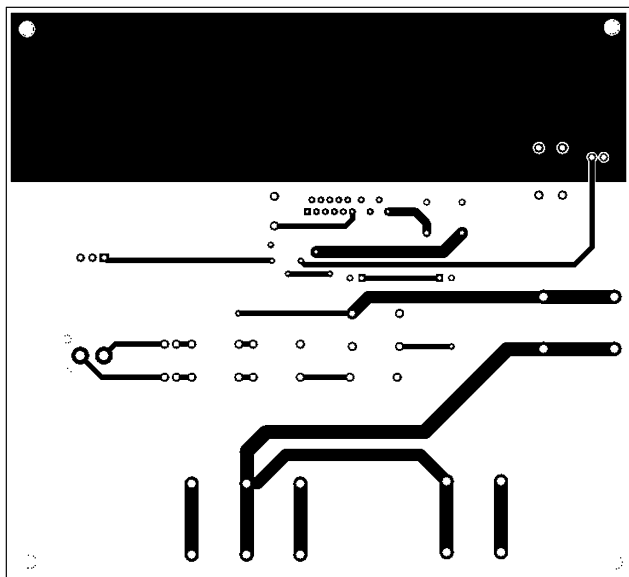

Figure 37. Top Layer

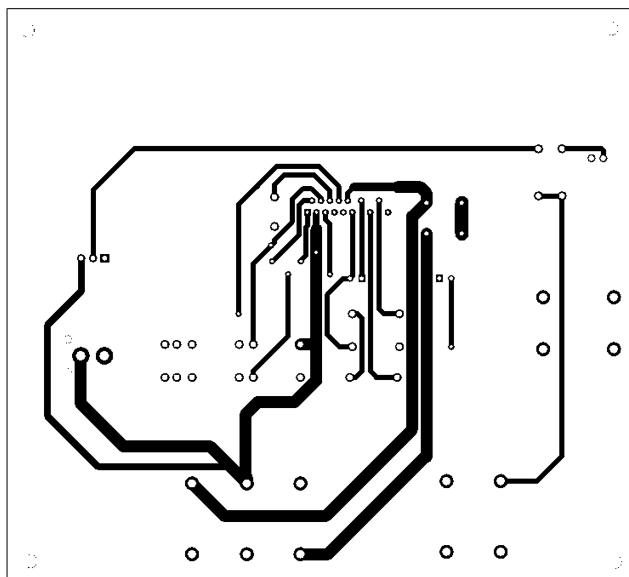



Figure 38. Bottom Layer

REVISION HISTORY

Rev	Date	Description
1.0	05/24/07	Initial WEB release.
1.01	05/29/07	Few text edits.
1.02	09/17/07	Edited curve 20216724.
C	04/05/13	Changed layout of National Data Sheet to TI format.

PACKAGING INFORMATION

Orderable Device	Status (1)	Package Type	Package Drawing	Pins	Package Qty	Eco Plan (2)	Lead/Ball Finish	MSL Peak Temp (3)	Op Temp (°C)	Device Marking (4/5)	Samples
LME49810TB/NOPB	ACTIVE	TO-OTHER	NDN	15	24	Green (RoHS & no Sb/Br)	CU SN	Level-1-NA-UNLIM	-20 to 85	LME49810 TB	

(1) The marketing status values are defined as follows:

ACTIVE: Product device recommended for new designs.

LIFEBUY: TI has announced that the device will be discontinued, and a lifetime-buy period is in effect.

NRND: Not recommended for new designs. Device is in production to support existing customers, but TI does not recommend using this part in a new design.

PREVIEW: Device has been announced but is not in production. Samples may or may not be available.

OBSOLETE: TI has discontinued the production of the device.

(2) Eco Plan - The planned eco-friendly classification: Pb-Free (RoHS), Pb-Free (RoHS Exempt), or Green (RoHS & no Sb/Br) - please check <http://www.ti.com/productcontent> for the latest availability information and additional product content details.

TBD: The Pb-Free/Green conversion plan has not been defined.

Pb-Free (RoHS): TI's terms "Lead-Free" or "Pb-Free" mean semiconductor products that are compatible with the current RoHS requirements for all 6 substances, including the requirement that lead not exceed 0.1% by weight in homogeneous materials. Where designed to be soldered at high temperatures, TI Pb-Free products are suitable for use in specified lead-free processes.

Pb-Free (RoHS Exempt): This component has a RoHS exemption for either 1) lead-based flip-chip solder bumps used between the die and package, or 2) lead-based die adhesive used between the die and leadframe. The component is otherwise considered Pb-Free (RoHS compatible) as defined above.

Green (RoHS & no Sb/Br): TI defines "Green" to mean Pb-Free (RoHS compatible), and free of Bromine (Br) and Antimony (Sb) based flame retardants (Br or Sb do not exceed 0.1% by weight in homogeneous material)

(3) MSL, Peak Temp. -- The Moisture Sensitivity Level rating according to the JEDEC industry standard classifications, and peak solder temperature.

(4) There may be additional marking, which relates to the logo, the lot trace code information, or the environmental category on the device.

(5) Multiple Device Markings will be inside parentheses. Only one Device Marking contained in parentheses and separated by a "~" will appear on a device. If a line is indented then it is a continuation of the previous line and the two combined represent the entire Device Marking for that device.

Important Information and Disclaimer: The information provided on this page represents TI's knowledge and belief as of the date that it is provided. TI bases its knowledge and belief on information provided by third parties, and makes no representation or warranty as to the accuracy of such information. Efforts are underway to better integrate information from third parties. TI has taken and continues to take reasonable steps to provide representative and accurate information but may not have conducted destructive testing or chemical analysis on incoming materials and chemicals. TI and TI suppliers consider certain information to be proprietary, and thus CAS numbers and other limited information may not be available for release.

In no event shall TI's liability arising out of such information exceed the total purchase price of the TI part(s) at issue in this document sold by TI to Customer on an annual basis.

NDN0015A

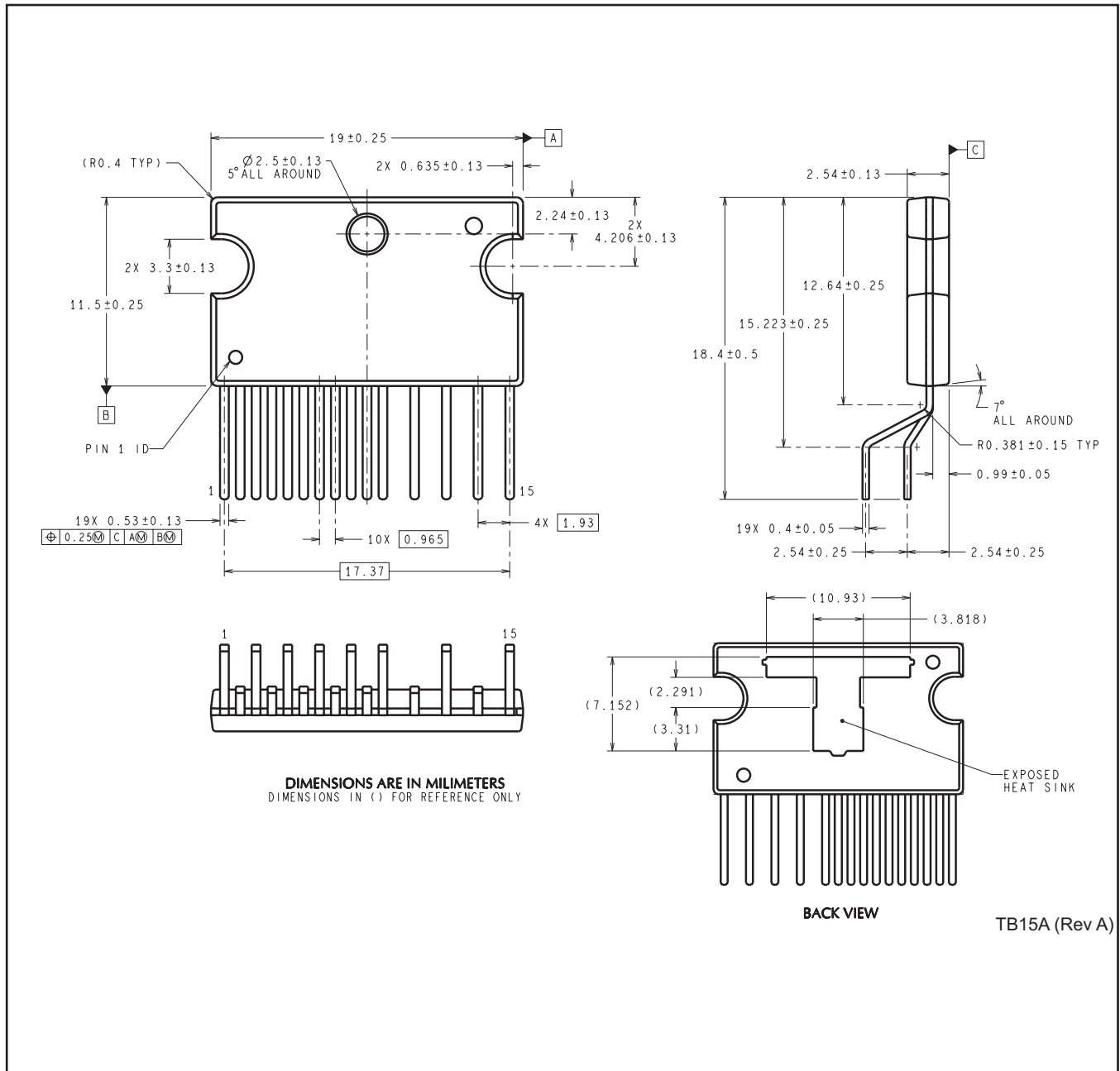

IMPORTANT NOTICE

Texas Instruments Incorporated and its subsidiaries (TI) reserve the right to make corrections, enhancements, improvements and other changes to its semiconductor products and services per JESD46, latest issue, and to discontinue any product or service per JESD48, latest issue. Buyers should obtain the latest relevant information before placing orders and should verify that such information is current and complete. All semiconductor products (also referred to herein as "components") are sold subject to TI's terms and conditions of sale supplied at the time of order acknowledgment.

TI warrants performance of its components to the specifications applicable at the time of sale, in accordance with the warranty in TI's terms and conditions of sale of semiconductor products. Testing and other quality control techniques are used to the extent TI deems necessary to support this warranty. Except where mandated by applicable law, testing of all parameters of each component is not necessarily performed.

TI assumes no liability for applications assistance or the design of Buyers' products. Buyers are responsible for their products and applications using TI components. To minimize the risks associated with Buyers' products and applications, Buyers should provide adequate design and operating safeguards.

TI does not warrant or represent that any license, either express or implied, is granted under any patent right, copyright, mask work right, or other intellectual property right relating to any combination, machine, or process in which TI components or services are used. Information published by TI regarding third-party products or services does not constitute a license to use such products or services or a warranty or endorsement thereof. Use of such information may require a license from a third party under the patents or other intellectual property of the third party, or a license from TI under the patents or other intellectual property of TI.

Reproduction of significant portions of TI information in TI data books or data sheets is permissible only if reproduction is without alteration and is accompanied by all associated warranties, conditions, limitations, and notices. TI is not responsible or liable for such altered documentation. Information of third parties may be subject to additional restrictions.

Resale of TI components or services with statements different from or beyond the parameters stated by TI for that component or service voids all express and any implied warranties for the associated TI component or service and is an unfair and deceptive business practice. TI is not responsible or liable for any such statements.

Buyer acknowledges and agrees that it is solely responsible for compliance with all legal, regulatory and safety-related requirements concerning its products, and any use of TI components in its applications, notwithstanding any applications-related information or support that may be provided by TI. Buyer represents and agrees that it has all the necessary expertise to create and implement safeguards which anticipate dangerous consequences of failures, monitor failures and their consequences, lessen the likelihood of failures that might cause harm and take appropriate remedial actions. Buyer will fully indemnify TI and its representatives against any damages arising out of the use of any TI components in safety-critical applications.

In some cases, TI components may be promoted specifically to facilitate safety-related applications. With such components, TI's goal is to help enable customers to design and create their own end-product solutions that meet applicable functional safety standards and requirements. Nonetheless, such components are subject to these terms.

No TI components are authorized for use in FDA Class III (or similar life-critical medical equipment) unless authorized officers of the parties have executed a special agreement specifically governing such use.

Only those TI components which TI has specifically designated as military grade or "enhanced plastic" are designed and intended for use in military/aerospace applications or environments. Buyer acknowledges and agrees that any military or aerospace use of TI components which have **not** been so designated is solely at the Buyer's risk, and that Buyer is solely responsible for compliance with all legal and regulatory requirements in connection with such use.

TI has specifically designated certain components as meeting ISO/TS16949 requirements, mainly for automotive use. In any case of use of non-designated products, TI will not be responsible for any failure to meet ISO/TS16949.

Products

Audio	www.ti.com/audio
Amplifiers	amplifier.ti.com
Data Converters	dataconverter.ti.com
DLP® Products	www.dlp.com
DSP	dsp.ti.com
Clocks and Timers	www.ti.com/clocks
Interface	interface.ti.com
Logic	logic.ti.com
Power Mgmt	power.ti.com
Microcontrollers	microcontroller.ti.com
RFID	www.ti-rfid.com
OMAP Applications Processors	www.ti.com/omap
Wireless Connectivity	www.ti.com/wirelessconnectivity

Applications

Automotive and Transportation	www.ti.com/automotive
Communications and Telecom	www.ti.com/communications
Computers and Peripherals	www.ti.com/computers
Consumer Electronics	www.ti.com/consumer-apps
Energy and Lighting	www.ti.com/energy
Industrial	www.ti.com/industrial
Medical	www.ti.com/medical
Security	www.ti.com/security
Space, Avionics and Defense	www.ti.com/space-avionics-defense
Video and Imaging	www.ti.com/video

TI E2E Community

e2e.ti.com